

RUGGED

Engineered to grip

PRODUCT DESCRIPTION

RUGGED CROC was developed to prevent cable theft by keeping the cable intrenched underground and securing it in place. It is made of an engineered polymer to withstand great stresses and forces that may be placed on the product.



RUGGED  **CROC**

Available Sizes:

- 25mm Rugged Croc - Range 20mm-35mm
- 50mm Rugged Croc - Range 35mm-75mm
- 95mm Rugged Croc - Range 75mm-120mm

RUGGED CROC SECURES YOUR CABLE FROM THEFT

www.theenergymarket.co.za

+27 83 735 6685 - tem@medcom.co.za

Proudly designed and manufactured
in South African.



PRODUCT SPECIFICATIONS

RUGGED CROC

PRODUCT SIZE:

	25mm	50mm	95mm
A	88mm	135mm	192mm
B	39.5mm	66mm	97mm
C	197mm	316mm	500mm

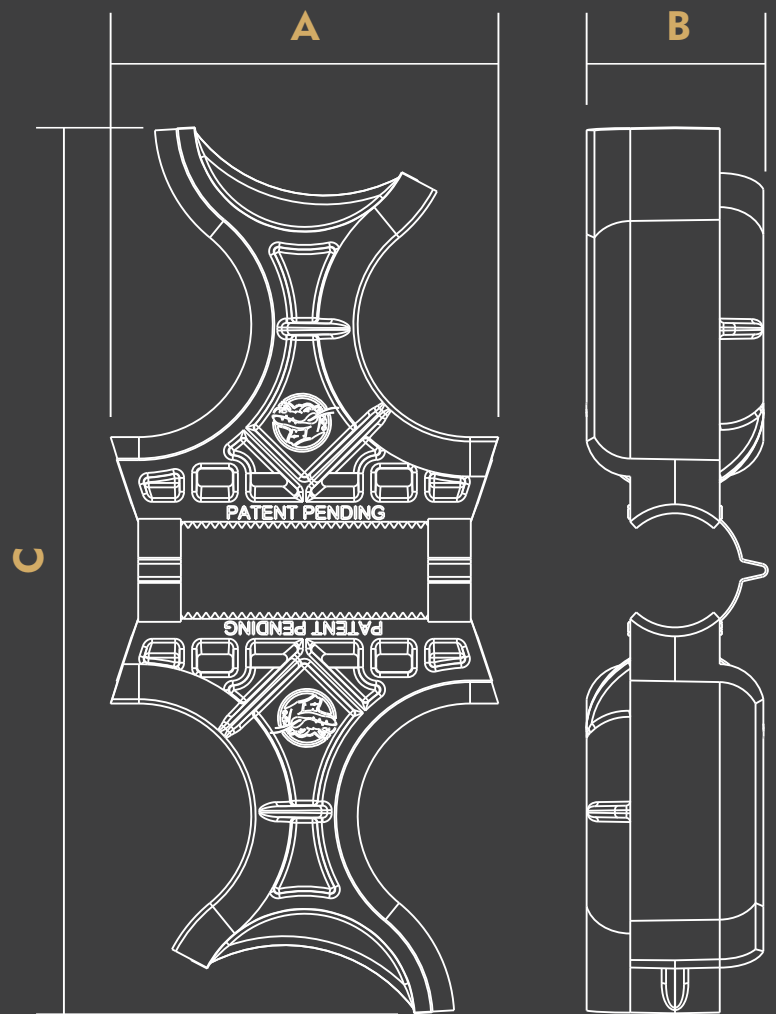

Product Assembly

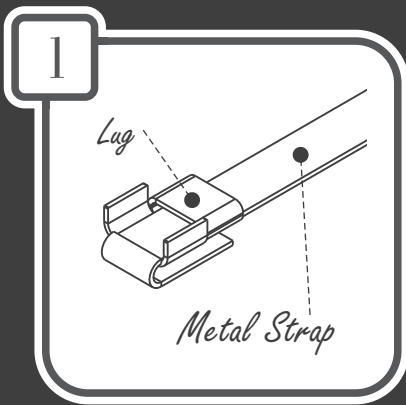

Feed strap through lug and crimp into position

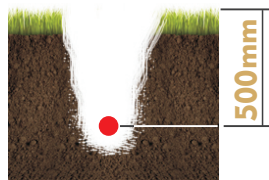

Trench depth

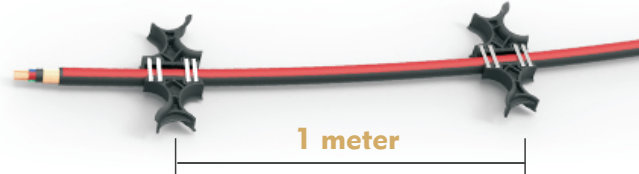

Place RUGGED CROC every 1 meter

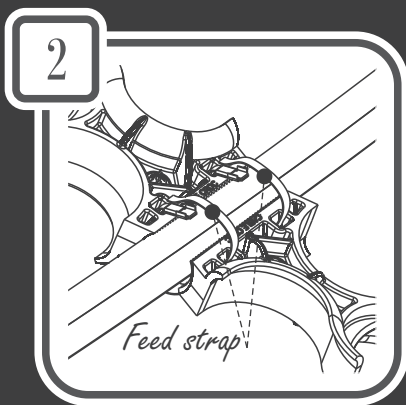

Place RUGGED Croc around cable and feed strap around

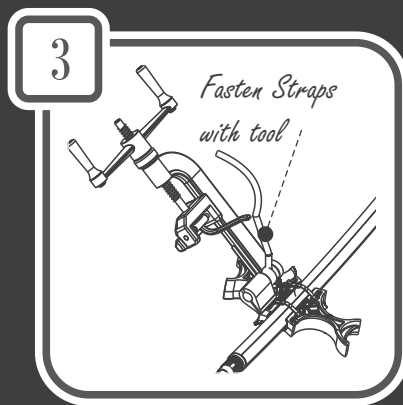

Fasten the strap using a tool to make sure that it is tight

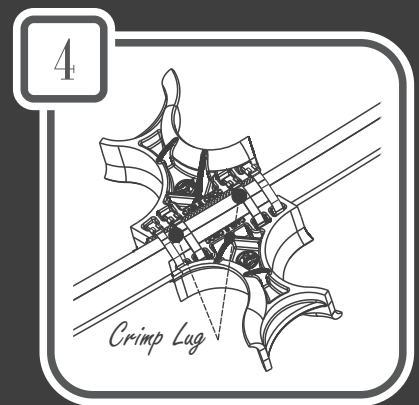

Flip the strap and crimp it in position. Use 4 straps for added strength and grip